

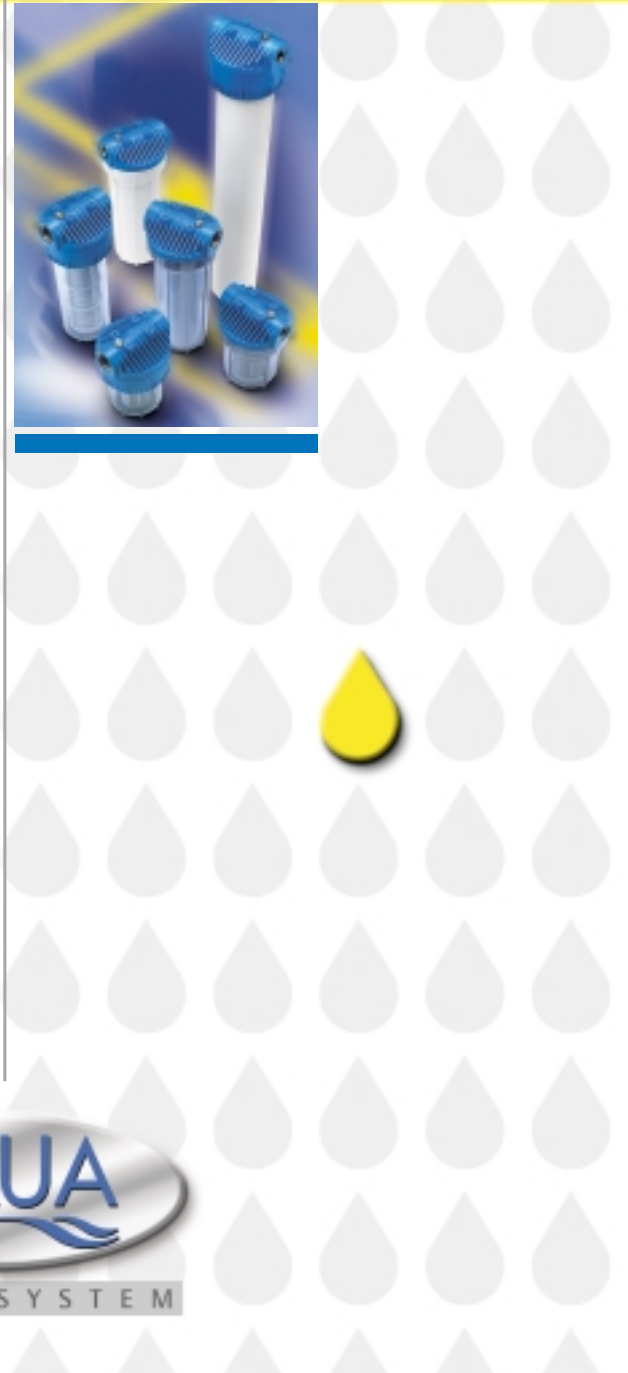

CONTAINERS FOR
CARTRIDGES







Water, a universal gift for every form of life putting the color back into water

The search for water and water itself is indispensable to life

For this reason it is necessary to treat water today, to take steps to make the water we find in nature usable. Too often this water is turned from a precious gift into a dangerous element.

This is due to pollution and environmental deterioration, both modern phenomena caused by increasing industrialization and by the sometimes abominable actions of human beings.

There are two important objectives to water treatment:

- to use water that would otherwise not be safe for use
- to dispose of polluted substances or

pollutants from industrial processes at a percentage of impurity that has been lowered to a level that is not harmful.

Aqua S.p.a. has been working in this direction in the water treatment sector for years. Through our wide range of products, we seek to provide efficient solutions for a market that is constantly evolving—the liquids filtering market.

It is our goal to find an answer to every problem. For this reason Aqua S.p.a. uses technologically advanced systems, beginning from the study and design of the prototype on down to the finished

product. Our innovative solutions are geared to a vast number of applications, which run from domestic, residential use to professional filtering, and which include micro-containers for very small spaces and small capacities, as well as stainless steel articles for the industrial sector.

The cartridge containers listed in this catalog, like all Aqua articles, have been designed and manufactured in conformity with public health and environmental safety regulations. Only the best quality, non-toxic plastic materials are used in our production.



SHORT LINE

This is a line of containers for small and extremely small cartridges. The line has been specially designed for applications where there is reduced installation space and minimum capacity. The Short Line includes the Micro Aqua, Mini Aqua, Aqua Net, Aqua Kid and Aqua Kid/Eco filters. All the containers in the line come without cartridges, and have white heads and transparent (Blue SAN) or white (Opaque PP) sump. Other colors are available upon request for bulk orders.

MICRO AND MINI AQUA are the smallest containers in the series. The unique shape of the head on these containers allows direct installation on the wall. These containers are particularly suitable for pre-filtering treatment on small electrical appliances and in any situation where a

minimum amount of water is required.

AQUA NET has been specially designed for vertical installation with in-take at the bottom and out-put at the top. Aqua Net is ideal for small-capacity devices and small areas, and can be applied to pipe fittings, hydro-cleaning machines, and beverage distributors.

AQUA KID handles medium capacity while featuring reduced dimensions. The head of Aqua Kid has three-way coupling to allow straight line or square assembly, depending on the size of the installation area.

AQUA KID/ECO is the alternative to the classical Aqua Kid container. While featuring the same technical characteristics, the head on Aqua Kid/Eco has a different look, and the container comes in an economical package.



short line

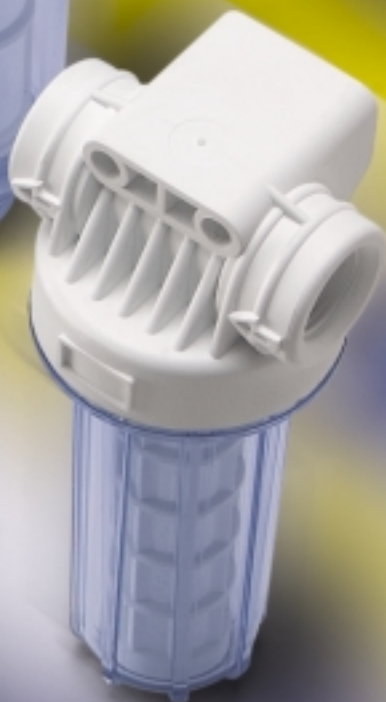

aqua mini / micro

TECHNICAL FEATURES

Head:	PP without brass inserts
Sump:	transparent SAN- PP white
O.RING:	NBR 70 Sh
Working pressure:	8 bar max
Burst pressure:	AQUA MINI: 44 bar max - AQUA MICRO: 43 bar max
Working temperature:	0°C + 50°C min/max
Capacity (empty) at 2 bar:	AQUA MINI: 1/4" 30 lt/min - AQUA MINI: 3/8" 47 lt/min AQUA MICRO: 1/4" 30 lt/min - AQUA MICRO: 3/8" 47 lt/min
Life test:	200.000 cycles from 0-10 bar

AQUA MICRO AND AQUA MINI CARTRIDGE FILTER HOUSING WITH WHITE TOP, TRANSPARENT OR OPAQUE WHITE SUMPS

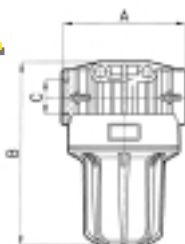

CODE	MOD	INLET/OUTLET c	DIMENSIONS a x b (mm)	QUANTITY box	VOLUME		kgs
					package		
A8030330	Micro V/T	1/4"F	58 x 88	50	0,276	5,70	
A8030340	Micro V/T	3/8"F	58 x 88	50	0,276	5,70	
A8030350	Micro V/OPB	1/4"F	58 x 88	50	0,276	5,70	
A8030360	Micro V/OPB	3/8"F	58 x 88	50	0,276	5,70	
A8030230	Mini V/T	1/4"F	58 x 135	28	0,276	4,13	
A8030240	Mini V/T	3/8"F	58 x 135	28	0,276	4,13	
A8030250	Mini V/OPB	1/4"F	58 x 135	28	0,276	4,13	
A8030260	Mini V/OPB	3/8"F	58 x 135	28	0,276	4,13	

Designed to hold defined cartridges

aqua net

TECHNICAL FEATURES

Head:	PP without brass inserts
Sump:	transparent SAN- PP white
O.RING:	NBR 70 Sh
Working pressure:	8 bar max
Burst pressure:	34 bar max
Working temperature:	0°C + 50°C min/max
Capacity (empty) at 2 bar:	3/4" 60 lt/min
Life test:	200.000 cycles from 0-10 bar

AQUA NET CARTRIDGE FILTER HOUSING WITH WHITE HEAD, TRANSPARENT AND OPAQUE WHITE SUMPS

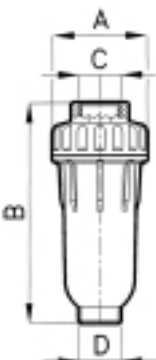

CODE	MOD	INLET/OUTLET c - ø	DIMENSIONS a x b (mm)	QUANTITY box	VOLUME		kgs
					package		
A8030110	Aqua Net V/T	3/4"F x 3/4"M	ø60 x 141	28	0,276	4,56	
A8030120	Aqua Net V/OPB	3/4"	ø60 x 141	28	0,276	4,56	

Designed to hold defined cartridges



aqua kid / kid/eco

TECHNICAL FEATURES

Head:	PP with brass inserts
Sump:	transparent SAN – PP white
O.RING:	NBR 70 Sh
Working pressure:	8 bar max
Burst pressure:	36 bar max
Working temperature:	0°C + 50°C min/max
Capacity (empty) at 2 bar:	1/2" 114 lt/min
Life test:	200.000 cycles from 0-10 bar



AQUA KID AND AQUA KID/ECO CARTRIDGE FILTER HOUSING WITH WHITE HEAD, TRANSPARENT OR OPAQUE WHITE SUMPS

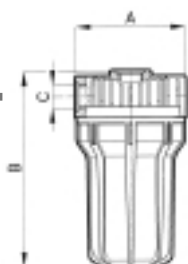

CODE	MOD	HEIGHT	INLET/OUTLET	DIMENSIONS	QUANTITY	VOLUME	kgs
			c	a x b (mm)			
A1010140	Kid V/T	5"	1/2"F	98 x 176	30	0,915	14,20
A1040190	Kid V/OPB	5"	1/2"F	98 x 176	30	0,915	14,20
A1010470	Kid/Eco V/T	5"	1/2"F	98 x 176	30	0,915	14,20
A1040480	Kid/Eco V/OPB	5"	1/2"F	98 x 176	30	0,915	14,20

Designed to hold cartridges:

5"

STANDARD LINE

This is a line of containers for FP2 cartridges with two-piece plastic filters and FP3 cartridges with three-piece plastic filters.

The heads are made with female-thread couplings with brass inserts and brass blow-off valves, or without brass inserts with plastic relief valves.

All containers are designed to hold standard filter cartridges measuring 5, 7, 9 3/4, 20 inches. They allow handling medium capacities, and are particularly suitable for domestic or residential use. The ring on the FP3 series facilitates opening and closing during maintenance.

A wrench for assembly is included in the accessories.

All containers come without cartridges, and have blue heads and transparent (Blue SAN)

or white (Opaque PP) sumps.

Other colors are available upon request for bulk orders.

The package is neutral, but may be personalized upon request for bulk orders.

standard line



FP2 standard

TECHNICAL FEATURES

Head:	PP with brass inserts
Sump:	transparent SAN – PP white
O.RING:	NBR 70 Sh
Working pressure:	8 bar max
Burst pressure:	35 bar max
Working temperature:	0°C + 50°C min/max
Capacity (empty) at 2 bar:	1/2" F 106,60 lt/min - 3/4" F 108,50 lt/min - 1" F 105,60 lt/min 1"1/4 F 230 lt/min - 1"1/2 F 230 lt/min
Life test:	200.000 cycles from 0-10 bar

FP2 FILTER CARTRIDGE HOUSINGS WITH BRASS INSERTS AND TRANSPARENT SAN SUMP



CODE	MOD	HEIGHT	INLET/OUTLET	DIMENSIONS		QUANTITY	kgs	VOLUME
				c	a x b (mm)			
A1010010	FP2	5"	1/2" F	122	x 174	24	18,59	0,112
A1010020	FP2	7"	1/2" F	122	x 226	12	11,65	0,091
A1010030	FP2	9" 3/4	1/2" F	122	x 294	12	13,20	0,091
A1010040	FP2	5"	3/4" F	122	x 174	24	19,00	0,112
A1010050	FP2	7"	3/4" F	122	x 226	12	11,85	0,091
A1010060	FP2	9" 3/4	3/4" F	122	x 294	12	13,36	0,091
A1010070	FP2	5"	1" F	122	x 179	24	19,55	0,112
A1010080	FP2	7"	1" F	122	x 231	12	12,11	0,091
A1010090	FP2	9" 3/4	1" F	122	x 299	12	13,60	0,091
A1010100	FP2	5"	1"1/4 F	122	x 189	24	21,40	0,112
A1010110	FP2	7"	1"1/4 F	122	x 241	12	13,00	0,091
A1010120	FP2	9" 3/4	1"1/4 F	126	x 319	12	14,66	0,091
A1010130	FP2	9" 3/4	1"1/2 F	126	x 325	12	15,17	0,091



D: 44
E: 33
F: ø4

Designed to hold cartridges:

5" 7" 9" 3/4 20"

FP2 FILTER CARTRIDGE HOUSINGS WITH BRASS INSERTS AND OPAQUE WHITE SUMP



CODE	MOD	HEIGHT	INLET/OUTLET	DIMENSIONS		QUANTITY	kgs	VOLUME
				c	a x b (mm)			
A1040010	FP2	5"	1/2" F	122	x 174	24	19,29	0,112
A1040020	FP2	7"	1/2" F	122	x 226	12	12,05	0,091
A1040030	FP2	9" 3/4	1/2" F	122	x 294	12	13,67	0,091
A1040040	FP2	20"	1/2" F	122	x 565	6	10,18	0,108
A1040050	FP2	5"	3/4" F	122	x 174	24	19,70	0,112
A1040060	FP2	7"	3/4" F	122	x 226	12	12,25	0,091
A1040070	FP2	9" 3/4	3/4" F	122	x 294	12	13,83	0,091
A1040080	FP2	20"	3/4" F	122	x 565	6	10,26	0,108
A1040090	FP2	5"	1" F	122	x 179	24	20,25	0,112
A1040100	FP2	7"	1" F	122	x 231	12	12,41	0,091
A1040110	FP2	9" 3/4	1" F	122	x 299	12	14,07	0,091
A1040120	FP2	20"	1" F	122	x 570	6	10,40	0,108
A1040130	FP2	5"	1"1/4 F	126	x 189	24	22,10	0,112
A1040140	FP2	7"	1"1/4 F	126	x 241	12	13,40	0,091
A1040150	FP2	9" 3/4	1"1/4 F	126	x 319	12	15,13	0,091
A1040160	FP2	20"	1"1/4 F	126	x 580	6	10,90	0,108
A1040170	FP2	9" 3/4	1"1/2 F	126	x 325	12	15,64	0,091
A1040180	FP2	20"	1"1/2 F	126	x 586	6	11,00	0,108

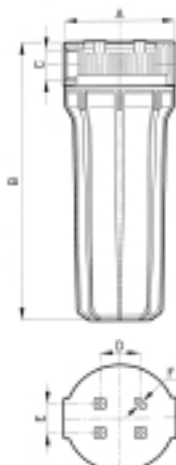

D: 44
E: 33
F: ø4



FP2 standard

TECHNICAL FEATURES

Head:	PP without brass inserts, blow-off valve in acetyl resin
Sump:	transparent SAN – PP white
O.RING:	NBR 70 Sh
Working pressure:	8 bar max
Burst pressure:	38 bar max
Working temperature:	0°C + 50°C min/max
Capacity (empty) at 2 bar:	1/4" F 32,83 lt/min - 3/8" F 86,70 lt/min - 1/2" F 106,60 lt/min 3/4" F 108,50 lt/min - 1" F 105,60 lt/min
Life test:	200.000 cycles from 0-10 bar

FP2 FILTER CARTRIDGE HOUSING WITHOUT BRASS INSERTS AND TRANSPARENT SAN SUMP



CODE	MOD	HEIGHT	INLET/OUTLET		DIMENSIONS	QUANTITY	kgs	VOLUME
			c	a x b (mm)				
A1020010	FP2	5"	1/4" F	118 x 170	24	16,60	0,112	
A1020020	FP2	7"	1/4" F	118 x 225	12	10,66	0,091	
A1020030	FP2	9" 3/4	1/4" F	118 x 302	12	12,17	0,091	
A1020040	FP2	5"	3/8" F	118 x 170	24	16,60	0,112	
A1020050	FP2	7"	3/8" F	118 x 225	12	10,66	0,091	
A1020060	FP2	9" 3/4	3/8" F	118 x 302	12	12,17	0,091	
A1020070	FP2	5"	1/2" F	122 x 178	24	18,90	0,112	
A1020080	FP2	7"	1/2" F	122 x 233	12	11,76	0,091	
A1020090	FP2	9" 3/4	1/2" F	122 x 310	12	13,28	0,091	
A1020100	FP2	5"	3/4" F	122 x 185	24	18,40	0,112	
A1020110	FP2	7"	3/4" F	122 x 240	12	11,52	0,091	
A1020120	FP2	9" 3/4	3/4" F	122 x 317	12	13,04	0,091	
A1020130	FP2	5"	1" F	122 x 193	24	19,16	0,112	
A1020140	FP2	7"	1" F	122 x 248	12	11,91	0,091	
A1020150	FP2	9" 3/4	1" F	122 x 325	12	13,04	0,091	

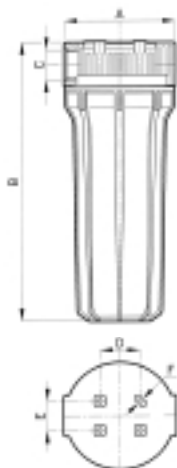

D: 44
E: 33
F: ø4

Designed to hold cartridges:

5" 7" 9" 3/4 20"

FP2 FILTER CARTRIDGE HOUSING WITHOUT BRASS INSERTS AND OPAQUE WHITE SUMP



CODE	MOD	HEIGHT	INLET/OUTLET		DIMENSIONS	QUANTITY	kgs	VOLUME
			c	a x b (mm)				
A1030010	FP2	5"	1/4" F	118 x 170	24	17,30	0,112	
A1030020	FP2	7"	1/4" F	118 x 225	12	11,06	0,091	
A1030030	FP2	9" 3/4	1/4" F	118 x 302	12	12,64	0,091	
A1030040	FP2	20"	1/4" F	118 x 562	6	9,68	0,108	
A1030050	FP2	5"	3/8" F	118 x 170	24	17,30	0,112	
A1030060	FP2	7"	3/8" F	118 x 225	12	11,06	0,091	
A1030070	FP2	9" 3/4	3/8" F	118 x 302	12	12,64	0,091	
A1030080	FP2	20"	3/8" F	118 x 562	6	9,68	0,108	
A1030090	FP2	5"	1/2" F	122 x 178	24	19,60	0,112	
A1030100	FP2	7"	1/2" F	122 x 233	12	12,16	0,091	
A1030110	FP2	9" 3/4	1/2" F	122 x 310	12	13,75	0,091	
A1030120	FP2	20"	1/2" F	122 x 570	6	10,24	0,108	
A1030130	FP2	5"	3/4" F	122 x 185	24	19,10	0,112	
A1030140	FP2	7"	3/4" F	122 x 240	12	11,92	0,091	
A1030150	FP2	9" 3/4	3/4" F	122 x 317	12	13,52	0,091	
A1030160	FP2	20"	3/4" F	122 x 577	6	10,12	0,108	
A1030170	FP2	5"	1" F	122 x 193	24	19,76	0,112	
A1030180	FP2	7"	1" F	122 x 248	12	12,31	0,091	
A1030190	FP2	9" 3/4	1" F	122 x 325	12	13,51	0,091	
A1030200	FP2	20"	1" F	122 x 585	6	10,32	0,108	

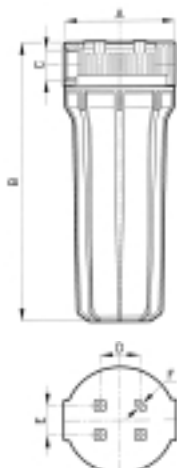

D: 44
E: 33
F: ø4

FP3 standard

TECHNICAL FEATURES

Head:	PP with brass inserts
Sump:	transparent SAN – PP white
Ring:	PP
O.RING:	NBR 70 Sh
Working pressure:	8 bar max
Burst pressure:	35 bar max
Working temperature:	0°C + 50°C min/max
Capacity (empty) at 2 bar:	1/2" F 106,60 lt/min - 3/4" F 108,50 lt/min - 1" F 105,60 lt/min 1"1/4 F 230 lt/min - 1"1/2 F 230 lt/min
Life test:	200.000 cycles from 0-10 bar

FP3 FILTER CARTRIDGE HOUSING WITH BRASS INSERT AND TRANSPARENT SUMP



CODE	MOD	HEIGHT	INLET/OUTLET	DIMENSIONS		QUANTITY	kgs	VOLUME
				c	a x b (mm)			
A2010010	FP3	5"	1/2" F	122 x 174	24	18,22	0,112	
A2010020	FP3	7"	1/2" F	122 x 226	12	11,11	0,091	
A2010030	FP3	9" 3/4	1/2" F	122 x 294	12	12,15	0,091	
A2010040	FP3	20"	1/2" F	122 x 565	6	9,53	0,108	
A2010050	FP3	5"	3/4" F	122 x 174	24	18,06	0,112	
A2010060	FP3	7"	3/4" F	122 x 226	12	11,07	0,091	
A2010070	FP3	9" 3/4	3/4" F	122 x 294	12	12,32	0,091	
A2010080	FP3	20"	3/4" F	122 x 565	6	9,62	0,108	
A2010090	FP3	5"	1" F	122 x 179	24	19,24	0,112	
A2010100	FP3	7"	1" F	122 x 231	12	11,40	0,091	
A2010110	FP3	9" 3/4	1" F	122 x 299	12	12,60	0,091	
A2010120	FP3	20"	1" F	122 x 570	6	9,76	0,108	
A2010130	FP3	5"	1"1/4 F	126 x 189	24	21,20	0,112	
A2010140	FP3	7"	1"1/4 F	126 x 241	12	12,43	0,091	
A2010150	FP3	9" 3/4	1"1/4 F	126 x 319	12	13,52	0,091	
A2010160	FP3	20"	1"1/4 F	126 x 580	6	10,27	0,108	
A2010170	FP3	9" 3/4	1"1/2 F	126 x 325	12	13,64	0,091	
A2010180	FP3	20"	1"1/2 F	126 x 586	6	10,32	0,108	

D: 44
E: 33
F: ø4

Designed to hold cartridges:

5" 7" 9" 3/4 20"

FP3 FILTER CARTRIDGE HOUSING WITH BRASS INSERT AND OPAQUE WHITE SUMP

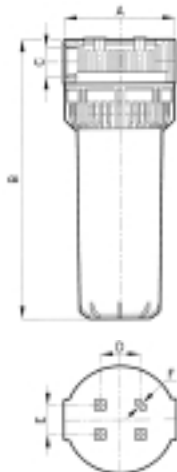

CODE	MOD	HEIGHT	INLET/OUTLET	DIMENSIONS		QUANTITY	kgs	VOLUME
				c	a x b (mm)			
A2040010	FP3	5"	1/2" F	122 x 174	24	18,74	0,112	
A2040020	FP3	7"	1/2" F	122 x 226	12	11,41	0,091	
A2040030	FP3	9" 3/4	1/2" F	122 x 294	12	12,15	0,091	
A2040040	FP3	20"	1/2" F	122 x 565	6	9,91	0,108	
A2040050	FP3	5"	3/4" F	122 x 174	24	18,57	0,112	
A2040060	FP3	7"	3/4" F	122 x 226	12	11,37	0,091	
A2040070	FP3	9" 3/4	3/4" F	122 x 294	12	12,32	0,091	
A2040080	FP3	20"	3/4" F	122 x 565	6	10,00	0,108	
A2040090	FP3	5"	1" F	122 x 179	24	19,76	0,112	
A2040100	FP3	7"	1" F	122 x 231	12	11,70	0,091	
A2040110	FP3	9" 3/4	1" F	122 x 299	12	12,60	0,091	
A2040120	FP3	20"	1" F	122 x 570	6	10,14	0,108	
A2040130	FP3	5"	1"1/4 F	126 x 189	24	21,72	0,112	
A2040140	FP3	7"	1"1/4 F	126 x 241	12	12,73	0,091	
A2040150	FP3	9" 3/4	1"1/4 F	126 x 319	12	13,52	0,091	
A2040160	FP3	20"	1"1/4 F	126 x 580	6	10,65	0,108	
A2040170	FP3	9" 3/4	1"1/2 F	126 x 325	12	13,64	0,091	
A2040180	FP3	20"	1"1/2 F	126 x 586	6	10,70	0,108	

D: 44
E: 33
F: ø4

FP3 standard

TECHNICAL FEATURES

Head:	PP without brass inserts, blow-off valve in acetyl resin
Sump:	transparent SAN – PP white
Ring:	PP
O.RING:	NBR 70 Sh
Working pressure:	8 bar max
Burst pressure:	35 bar max
Working temperature:	0°C + 50°C min/max
Capacity (empty) at 2 bar:	1/4" F 32,83 lt/min - 3/8" F 86,70 lt/min - 1/2" F 106,60 lt/min 3/4" F 108,50 lt/min - 1" F 105,60 lt/min
Life test:	200.000 cycles from 0-10 bar

FP3 FILTER CARTRIDGE HOUSING WITHOUT BRASS INSERT AND TRANSPARENT SUMP

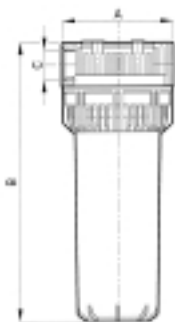

CODE	MOD	HEIGHT	INLET/OUTLET	DIMENSIONS		QUANTITY	kgs	VOLUME
				c	a x b (mm)			
A2020010	FP3	5"	1/4" F	118 x 170	24	16,23	0,112	
A2020020	FP3	7"	1/4" F	118 x 225	12	9,96	0,091	
A2020030	FP3	9" 3/4	1/4" F	118 x 302	12	11,16	0,091	
A2020040	FP3	20"	1/4" F	118 x 562	6	9,03	0,108	
A2020050	FP3	5"	3/8" F	118 x 170	24	16,23	0,112	
A2020060	FP3	7"	3/8" F	118 x 225	12	9,96	0,091	
A2020070	FP3	9" 3/4	3/8" F	118 x 302	12	11,16	0,091	
A2020080	FP3	20"	3/8" F	118 x 562	6	9,03	0,108	
A2020090	FP3	5"	1/2" F	122 x 178	24	18,51	0,112	
A2020100	FP3	7"	1/2" F	122 x 233	12	11,09	0,091	
A2020110	FP3	9" 3/4	1/2" F	122 x 310	12	12,29	0,091	
A2020120	FP3	20"	1/2" F	122 x 570	6	9,60	0,108	
A2020130	FP3	5"	3/4" F	122 x 185	24	18,05	0,112	
A2020140	FP3	7"	3/4" F	122 x 240	12	10,83	0,091	
A2020150	FP3	9" 3/4	3/4" F	122 x 317	12	12,02	0,091	
A2020160	FP3	20"	3/4" F	122 x 577	6	9,47	0,108	
A2020170	FP3	5"	1" F	122 x 193	24	18,84	0,112	
A2020180	FP3	7"	1" F	122 x 248	12	11,23	0,091	
A2020190	FP3	9" 3/4	1" F	122 x 325	12	12,45	0,091	
A2020200	FP3	20"	1" F	122 x 585	6	9,67	0,108	

D: 44
E: 33
F: ø4

Designed to hold cartridges:

5" 7" 9" 3/4 20"

FP3 FILTER CARTRIDGE HOUSING WITHOUT BRASS INSERT AND OPAQUE WHITE SUMP

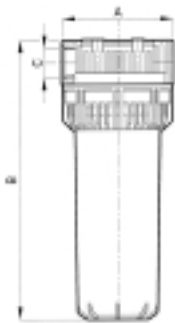

CODE	MOD	HEIGHT	INLET/OUTLET	DIMENSIONS		QUANTITY	kgs	VOLUME
				c	a x b (mm)			
A2030010	FP3	5"	1/4" F	118 x 170	24	16,75	0,112	
A2030020	FP3	7"	1/4" F	118 x 225	12	10,26	0,091	
A2030030	FP3	9" 3/4	1/4" F	118 x 302	12	11,16	0,091	
A2030040	FP3	20"	1/4" F	118 x 562	6	9,41	0,108	
A2030050	FP3	5"	3/8" F	118 x 170	24	16,75	0,112	
A2030060	FP3	7"	3/8" F	118 x 225	12	10,26	0,091	
A2030070	FP3	9" 3/4	3/8" F	118 x 302	12	11,16	0,091	
A2030080	FP3	20"	3/8" F	118 x 562	6	9,41	0,108	
A2030090	FP3	5"	1/2" F	122 x 178	24	19,03	0,112	
A2030100	FP3	7"	1/2" F	122 x 233	12	11,39	0,091	
A2030110	FP3	9" 3/4	1/2" F	122 x 310	12	12,29	0,091	
A2030120	FP3	20"	1/2" F	122 x 570	6	9,98	0,108	
A2030130	FP3	5"	3/4" F	122 x 185	24	18,57	0,112	
A2030140	FP3	7"	3/4" F	122 x 240	12	11,13	0,091	
A2030150	FP3	9" 3/4	3/4" F	122 x 317	12	12,02	0,091	
A2030160	FP3	20"	3/4" F	122 x 577	6	9,85	0,108	
A2030170	FP3	5"	1" F	122 x 193	24	19,36	0,112	
A2030180	FP3	7"	1" F	122 x 248	12	11,53	0,091	
A2030190	FP3	9" 3/4	1" F	122 x 325	12	12,45	0,091	
A2030200	FP3	20"	1" F	122 x 585	6	10,15	0,108	

AQUAFIN LINE

Like Aqualux, the AQUAFIN line is a series of cartridge containers designed to offer improved performance.

The head of the container has been designed with special vertical ribbing, which lends greater stability and provides increased resistance to pressure.

Aquafin is available both in the FP2/1 series with two-piece plastic filters and in the FP3/1 series with three-piece plastic filters.

The heads in the Aquafin line are made exclusively with female-thread couplings with brass inserts and brass relief valves, and are all designed for wall mounting. All containers are designed to hold standard filter cartridges measuring 5, 7, 9 3/4, 20 inches. They allow handling medium capacities, and are particularly suitable for

domestic or residential use. The ring on the FP3 series facilitates opening and closing during maintenance. A wrench for assembly is included in the accessories. All containers come without cartridges, and have blue heads and transparent (Blue SAN) or white (Opaque PP) sumps.

Other colors are available upon request for bulk orders.

The package is neutral, but may be personalized upon request for bulk orders.

aquafin line



FP2/1 aquafin

TECHNICAL FEATURES

Head:	PP with brass inserts
Sump:	transparent SAN – PP white
O.RING:	NBR 70 Sh
Working pressure:	8 bar max
Burst pressure:	35 bar max
Working temperature:	0°C + 50°C min/max
Capacity (empty) at 2 bar:	1/2" F 106,60 lt/min - 3/4" F 108,50 lt/min - 1" F 105,60 lt/min 1"1/4 F 230 lt/min
Life test:	200.000 cycles from 0-10 bar

FP2/1 FILTER CARTRIDGE HOUSING WITH TRANSPARENT SUMP



CODE	MOD	HEIGHT	INLET/OUTLET	DIMENSIONS	QUANTITY	kgs	VOLUME
					box		package
A1010500	FP2/1	5"	1/2" F	122 x 186	24	19,50	0,112
A1010510	FP2/1	7"	1/2" F	122 x 236	12	12,10	0,091
A1010520	FP2/1	9" 3/4	1/2" F	122 x 308	12	13,62	0,091
A1010530	FP2/1	5"	3/4" F	122 x 186	24	20,05	0,112
A1010540	FP2/1	7"	3/4" F	122 x 236	12	12,39	0,091
A1010430	FP2/1	9" 3/4	3/4" F	122 x 308	12	13,90	0,091
A1010550	FP2/1	5"	1" F	122 x 186	24	20,12	0,112
A1010560	FP2/1	7"	1" F	122 x 236	12	12,41	0,091
A1010440	FP2/1	9" 3/4	1" F	122 x 308	12	13,92	0,091
A1010570	FP2/1	5"	1"1/4 F	124 x 186	24	21,78	0,112
A1010580	FP2/1	7"	1"1/4 F	124 x 236	12	13,23	0,091
A1010590	FP2/1	9" 3/4	1"1/4 F	124 x 308	12	14,75	0,091

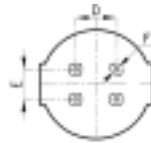

D: 44
E: 33
F: ø4

Designed to hold cartridges:

5" 7" 9" 3/4 20"

FP2/1 FILTER CARTRIDGE HOUSING WITH OPAQUE WHITE SUMP



CODE	MOD	HEIGHT	INLET/OUTLET	DIMENSIONS	QUANTITY	kgs	VOLUME
					box		package
A1040500	FP2/1	5"	1/2" F	122 x 186	24	20,20	0,112
A1040510	FP2/1	7"	1/2" F	122 x 236	12	12,50	0,091
A1040520	FP2/1	9" 3/4	1/2" F	122 x 308	12	14,09	0,091
A1040530	FP2/1	20"	1/2" F	122 x 566	6	10,40	0,108
A1040540	FP2/1	5"	3/4" F	122 x 186	24	20,75	0,112
A1040550	FP2/1	7"	3/4" F	122 x 236	12	12,79	0,091
A1040560	FP2/1	9" 3/4	3/4" F	122 x 308	12	14,37	0,091
A1040570	FP2/1	20"	3/4" F	122 x 566	6	10,54	0,108
A1040580	FP2/1	5"	1" F	122 x 186	24	20,72	0,112
A1040590	FP2/1	7"	1" F	122 x 236	12	12,81	0,091
A1040600	FP2/1	9" 3/4	1" F	122 x 308	12	14,39	0,091
A1040610	FP2/1	20"	1" F	122 x 566	6	10,57	0,108
A1040620	FP2/1	5"	1"1/4 F	124 x 186	24	22,48	0,112
A1040630	FP2/1	7"	1"1/4 F	124 x 236	12	13,43	0,091
A1040640	FP2/1	9" 3/4	1"1/4 F	124 x 308	12	15,22	0,091
A1040650	FP2/1	20"	1"1/4 F	124 x 566	6	10,10	0,108

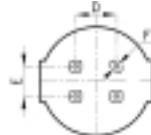
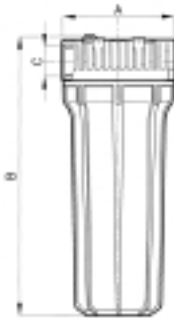

D: 44
E: 33
F: ø4

FP3/1 aquafin

TECHNICAL FEATURES

Head:	PP with brass inserts
Sump:	transparent SAN – PP white
Ring:	PP
O.RING:	NBR 70 Sh
Working pressure:	8 bar max
Burst pressure:	35 bar max
Working temperature:	0°C + 50°C min/max
Capacity (empty) at 2 bar:	1/2°F 106,60 lt/min - 3/4°F 108,50 lt/min - 1°F 105,60 lt/min 1*1/4F 230 lt/min
Life test:	200.000 cycles from 0-10 bar

FP3/1 FILTER CARTRIDGE HOUSING WITH TRANSPARENT SUMP



CODE	MOD	HEIGHT	INLET/OUTLET	DIMENSIONS	QUANTITY		VOLUME
					box	confez.	
A2010730	FP3/1	5"	1/2°F	122 x 185	24	19,02	0,112
A2010910	FP3/1	7"	1/2°F	122 x 236	12	11,40	0,091
A2010470	FP3/1	9*3/4	1/2°F	122 x 306	12	12,61	0,091
A2010920	FP3/1	20"	1/2°F	122 x 566	6	9,77	0,108
A2010930	FP3/1	5"	3/4°F	122 x 185	24	19,74	0,112
A2010940	FP3/1	7"	3/4°F	122 x 236	12	11,69	0,091
A2010320	FP3/1	9*3/4	3/4°F	122 x 306	12	12,90	0,091
A2010660	FP3/1	20"	3/4°F	122 x 566	6	9,90	0,108
A2010950	FP3/1	5"	1°F	122 x 185	24	19,78	0,112
A2010790	FP3/1	7"	1°F	122 x 236	12	11,71	0,091
A2010310	FP3/1	9*3/4	1°F	122 x 306	12	12,93	0,091
A2010780	FP3/1	20"	1°F	122 x 566	6	9,93	0,108
A2010960	FP3/1	5"	1*1/4F	124 x 185	24	21,42	0,112
A2010970	FP3/1	7"	1*1/4F	124 x 236	12	11,95	0,091
A2010980	FP3/1	9*3/4	1*1/4F	124 x 306	12	13,74	0,091
A2010990	FP3/1	20"	1*1/4F	124 x 566	6	10,31	0,108

D: 44
E: 33
F: ø4

Designed to hold cartridges:

5" 7" 9" 3/4 20"

FP3/1 FILTER CARTRIDGE HOUSING WITH OPAQUE WHITE SUMP



CODE	MOD	HEIGHT	INLET/OUTLET	DIMENSIONS	QUANTITY		VOLUME
					box	confez.	
A2040720	FP3/1	5"	1/2°F	122 x 185	24	19,54	0,112
A2040730	FP3/1	7"	1/2°F	122 x 236	12	11,10	0,091
A2040740	FP3/1	9*3/4	1/2°F	122 x 306	12	12,61	0,091
A2040750	FP3/1	20"	1/2°F	122 x 566	6	10,15	0,108
A2040760	FP3/1	5"	3/4°F	122 x 185	24	20,26	0,112
A2040770	FP3/1	7"	3/4°F	122 x 236	12	11,99	0,091
A2040520	FP3/1	9*3/4	3/4°F	122 x 306	12	12,90	0,091
A2040780	FP3/1	20"	3/4°F	122 x 566	6	10,29	0,108
A2040790	FP3/1	5"	1°F	122 x 185	24	20,31	0,112
A2040800	FP3/1	7"	1°F	122 x 236	12	12,01	0,091
A2040580	FP3/1	9*3/4	1°F	122 x 306	12	12,93	0,091
A2040630	FP3/1	20"	1°F	122 x 566	6	10,31	0,108
A2040810	FP3/1	5"	1*1/4F	124 x 185	24	21,94	0,112
A2040820	FP3/1	7"	1*1/4F	124 x 236	12	12,25	0,091
A2040830	FP3/1	9*3/4	1*1/4F	124 x 306	12	13,74	0,091
A2040840	FP3/1	20"	1*1/4F	124 x 566	6	10,70	0,108

D: 44
E: 33
F: ø4

HYDRO LINE

Hydro Line is an alternative to the Standard line. It has a different look to the head, while maintaining the same technical characteristics as the Standard line.

The Hydro line is available both in the FP2/2 series with two-piece plastic filters, and in the FP3/2 series with three-piece plastic filters. Unlike the Standard line, the Hydro line is designed exclusively with female-thread couplings with brass inserts and brass relief valves. The line is designed for wall mounting.

All containers are designed to hold standard filter cartridges measuring 5, 7, 9 3/4, 20 inches. They allow handling medium capacities, and are particularly suitable for domestic or residential use. The ring on the FP3 series facilitates opening and closing

during maintenance.

A wrench for assembly is included in the accessories.

All containers come without cartridges, and have blue heads and transparent (Blue SAN) or white (Opaque PP) sumps.

Other colors are available upon request for bulk orders.

The package is neutral, but may be personalized upon request for bulk orders.

hydro line



FP2/2 hydro

TECHNICAL FEATURES

Head:	PP with brass inserts
Sump:	transparent SAN- PP white
O.RING:	NBR 70 Sh
Working pressure:	8 bar max
Burst pressure:	35 bar max
Working temperature:	0°C + 50°C min/max
Capacity (empty) at 2 bar:	1/2" F 106,60 lt/min - 3/4" F 108,50 lt/min - 1" F 105,60 lt/min
Life test:	200.000 cycles from 0-10 bar



FP2/2 FILTER CARTRIDGE HOUSING WITH TRANSPARENT SAN SUMP

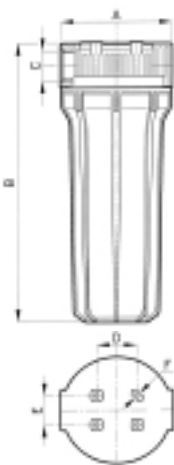

CODE	MOD	HEIGHT	INLET/OUTLET	DIMENSIONS	QUANTITY	kgs	VOLUME	
								c
A1010160	FP2/2	5"	1/2" F	122 x 190	24	19,35	0,112	
A1010170	FP2/2	7"	1/2" F	122 x 241	12	12,74	0,091	
A1010180	FP2/2	9" 3/4	1/2" F	122 x 312	12	13,05	0,091	
A1010270	FP2/2	5"	3/4" F	122 x 190	24	19,73	0,112	
A1010280	FP2/2	7"	3/4" F	122 x 241	12	12,23	0,091	
A1010290	FP2/2	9" 3/4	3/4" F	122 x 312	12	13,76	0,091	
A1010250	FP2/2	5"	1" F	122 x 190	24	19,61	0,112	
A1010190	FP2/2	7"	1" F	122 x 241	12	12,17	0,091	
A1010200	FP2/2	9" 3/4	1" F	122 x 312	12	13,70	0,091	

D: 44
E: 33
F: ø4

Designed to hold cartridges:

5" 7" 9" 3/4 20"



FP2/2 FILTER CARTRIDGE HOUSING WITH OPAQUE WHITE SUMP



CODE	MOD	HEIGHT	INLET/OUTLET	DIMENSIONS	QUANTITÀ	kgs	VOLUME	
								c
A1040210	FP2/2	5"	1/2" F	122 x 190	24	20,05	0,112	
A1040220	FP2/2	7"	1/2" F	122 x 241	12	13,14	0,091	
A1040230	FP2/2	9" 3/4	1/2" F	122 x 312	12	13,52	0,091	
A1040240	FP2/2	20"	1/2" F	122 x 570	6	10,03	0,108	
A1040250	FP2/2	5"	3/4" F	122 x 190	24	20,43	0,112	
A1040260	FP2/2	7"	3/4" F	122 x 241	12	12,63	0,091	
A1040270	FP2/2	9" 3/4	3/4" F	122 x 312	12	14,23	0,091	
A1040280	FP2/2	20"	3/4" F	122 x 570	6	10,49	0,108	
A1040290	FP2/2	5"	1" F	122 x 190	24	20,31	0,112	
A1040300	FP2/2	7"	1" F	122 x 241	12	12,47	0,091	
A1040310	FP2/2	9" 3/4	1" F	122 x 312	12	14,17	0,091	
A1040320	FP2/2	20"	1" F	122 x 570	6	10,46	0,108	

D: 44
E: 33
F: ø4



FP3/2 hydro

TECHNICAL FEATURES

Head:	PP with brass inserts
Sump:	transparent SAN – PP white
Ring:	PP
O.RING:	NBR 70 Sh
Working pressure:	8 bar max
Burst pressure:	35 bar max
Working temperature:	0°C + 50°C min/max
Capacity (empty) at 2 bar:	1/2" F 106,60 lt/min - 3/4" F 108,50 lt/min - 1" F 105,60 lt/min
Life test:	200.000 cycles from 0-10 bar



FP3/2 FILTER CARTRIDGE HOUSING WITH TRANSPARENT SAN SUMP

CODE	MOD	HEIGHT	INLET/OUTLET	DIMENSIONS	QUANTITY	kgs	VOLUME	
								c
A2010510	FP3/2	5"	1/2" F	122 x 189	24	19,04	0,112	
A2010270	FP3/2	7"	1/2" F	122 x 241	12	11,34	0,091	
A2010280	FP3/2	9" 3/4	1/2" F	122 x 311	12	12,54	0,091	
A2010670	FP3/2	20"	1/2" F	122 x 571	6	9,72	0,108	
A2010520	FP3/2	5"	3/4" F	122 x 189	24	19,44	0,112	
A2010530	FP3/2	7"	3/4" F	122 x 241	12	11,55	0,091	
A2010540	FP3/2	9" 3/4	3/4" F	122 x 311	12	12,75	0,091	
A2010680	FP3/2	20"	3/4" F	122 x 571	6	9,82	0,108	
A2010550	FP3/2	5"	1" F	122 x 189	24	19,32	0,112	
A2010560	FP3/2	7"	1" F	122 x 241	12	11,48	0,091	
A2010570	FP3/2	9" 3/4	1" F	122 x 311	12	12,67	0,091	
A2010690	FP3/2	20"	1" F	122 x 571	6	9,79	0,108	

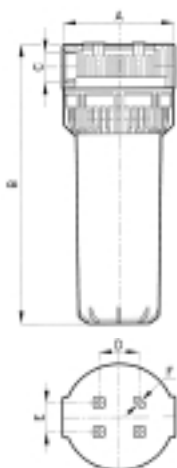

D: 44
E: 33
F: ø4

Designed to hold cartridges:

5" 7" 9" 3/4 20"



FP3/2 FILTER CARTRIDGE HOUSING WITH OPAQUE WHITE SUMP

CODE	MOD	HEIGHT	INLET/OUTLET	DIMENSIONS	QUANTITY	kgs	VOLUME	
								c
A2040260	FP3/2	5"	1/2" F	122 x 189	24	19,56	0,112	
A2040270	FP3/2	7"	1/2" F	122 x 241	12	11,64	0,091	
A2040280	FP3/2	9" 3/4	1/2" F	122 x 311	12	12,54	0,091	
A2040450	FP3/2	20"	1/2" F	122 x 571	6	10,10	0,108	
A2040290	FP3/2	5"	3/4" F	122 x 189	24	19,97	0,112	
A2040300	FP3/2	7"	3/4" F	122 x 241	12	11,85	0,091	
A2040310	FP3/2	9" 3/4	3/4" F	122 x 311	12	12,75	0,091	
A2040460	FP3/2	20"	3/4" F	122 x 571	6	10,20	0,108	
A2040320	FP3/2	5"	1" F	122 x 189	24	19,85	0,112	
A2040330	FP3/2	7"	1" F	122 x 241	12	11,78	0,091	
A2040340	FP3/2	9" 3/4	1" F	122 x 311	12	12,67	0,091	
A2040470	FP3/2	20"	1" F	122 x 571	6	10,17	0,108	

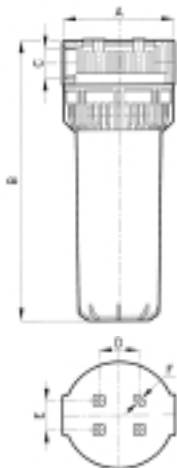

D: 44
E: 33
F: ø4

AQUALUX LINE

The Aqualux Line cartridge containers have been designed for excellent seal. Unlike the other lines, the heads on the Aqualux containers have a special spherical shape created by circular ribbing, which lends greater stability and provides increased resistance to pressure and improved performance.

The Aqualux Line is available in both the FP2/3 series with two-piece plastic filters and the FP3/3 series with three-piece plastic filters.

The Aqualux Line is designed exclusively with female-thread couplings with brass inserts and brass relief valves. The line is designed for wall mounting. All containers are designed to hold standard filter cartridges measuring 5, 7, 9 3/4, 20 inches.

They allow handling medium capacities, and are particularly suitable for domestic or residential use. The ring on the FP3 series facilitates opening and closing during maintenance.

A wrench for assembly is included in the accessories.

All containers come without cartridges, and have blue heads and transparent (Blue SAN) or white (Opaque PP) sumps.

Other colors are available upon request for bulk orders.

The package is neutral, but may be personalized upon request for bulk orders.

aqualux line



FP2/3 aqualux

TECHNICAL FEATURES

Head:	PP with brass inserts
Sump:	transparent SAN- PP white
O.RING:	NBR 70 Sh
Working pressure:	8 bar max
Burst pressure:	35 bar max
Working temperature:	0°C + 50°C min/max
Capacity (empty) at 2 bar:	1/2°F 106,60 lt/min - 3/4°F 108,50 lt/min - 1°F 105,60 lt/min
Life test:	200.000 cycles from 0-10 bar



FP2/3 FILTER CARTRIDGE HOUSING WITH TRANSPARENT SAN SUMP

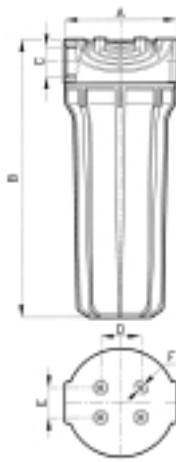

CODE	MOD	HEIGHT	INLET/OUTLET c	DIMENSIONS a x b (mm)	QUANTITY	kgs	VOLUME
					box		package
A1010300	FP2/3	5"	1/2°F	122 x 190	24	20,55	0,112
A1010310	FP2/3	7"	1/2°F	122 x 240	12	12,62	0,091
A1010320	FP2/3	9*3/4	1/2°F	122 x 312	12	14,14	0,091
A1010330	FP2/3	5"	3/4°F	122 x 190	24	20,86	0,112
A1010340	FP2/3	7"	3/4°F	122 x 240	12	12,77	0,091
A1010350	FP2/3	9*3/4	3/4°F	122 x 312	12	14,29	0,091
A1010360	FP2/3	5"	1°F	122 x 190	24	20,74	0,112
A1010370	FP2/3	7"	1°F	122 x 240	12	12,72	0,091
A1010380	FP2/3	9*3/4	1°F	122 x 312	12	14,24	0,091

D: 44
E: 33
F: ø4

Designed to hold cartridges:

5" 7" 9" 3/4 20"



FP2/3 FILTER CARTRIDGE HOUSING WITH OPAQUE WHITE SUMP



CODE	MOD	HEIGHT	INLET/OUTLET c	DIMENSIONS a x b (mm)	QUANTITY	kgs	VOLUME
					box		package
A1040330	FP2/3	5"	1/2°F	122 x 190	24	21,25	0,112
A1040340	FP2/3	7"	1/2°F	122 x 240	12	13,02	0,091
A1040350	FP2/3	9*3/4	1/2°F	122 x 312	12	14,61	0,091
A1040360	FP2/3	20"	1/2°F	122 x 570	6	10,66	0,108
A1040370	FP2/3	5"	3/4°F	122 x 190	24	21,56	0,112
A1040380	FP2/3	7"	3/4°F	122 x 240	12	13,17	0,091
A1040390	FP2/3	9*3/4	3/4°F	122 x 312	12	14,76	0,091
A1040400	FP2/3	20"	3/4°F	122 x 570	6	10,73	0,108
A1040410	FP2/3	5"	1°F	122 x 190	24	21,44	0,112
A1040420	FP2/3	7"	1°F	122 x 240	12	13,12	0,091
A1040430	FP2/3	9*3/4	1°F	122 x 312	12	14,71	0,091
A1040440	FP2/3	20"	1°F	122 x 570	6	10,71	0,108

D: 44
E: 33
F: ø4

FP3/3 aqualux

TECHNICAL FEATURES

Head:	PP with brass inserts
Sump:	transparent SAN- PP white
RING:	PP
O.RING:	NBR 70 Sh
Working pressure:	8 bar max
Burst pressure:	35 bar max
Working temperature:	0°C + 50°C min/max
Capacity (empty) at 2 bar:	1/2" F 106,60 lt/min - 3/4" F 108,50 lt/min - 1" F 105,60 lt/min
Life test:	200.000 cycles from 0-10 bar



FP3/3 FILTER CARTRIDGE HOUSING WITH TRANSPARENT SAN SUMP

CODE	MOD	HEIGHT	INLET/OUTLET	DIMENSIONS	QUANTITY	kgs	VOLUME	
								c
A2010580	FP3/3	5"	1/2" F	122 x 189	24	20,21	0,112	
A2010590	FP3/3	7"	1/2" F	122 x 240	12	11,94	0,091	
A2010500	FP3/3	9" 3/4	1/2" F	122 x 311	12	13,08	0,091	
A2010700	FP3/3	20"	1/2" F	122 x 570	6	10,02	0,108	
A2010600	FP3/3	5"	3/4" F	122 x 189	24	20,52	0,112	
A2010610	FP3/3	7"	3/4" F	122 x 240	12	12,08	0,091	
A2010620	FP3/3	9" 3/4	3/4" F	122 x 311	12	13,27	0,091	
A2010710	FP3/3	20"	3/4" F	122 x 570	6	10,09	0,108	
A2010630	FP3/3	5"	1" F	122 x 189	24	20,40	0,112	
A2010640	FP3/3	7"	1" F	122 x 240	12	12,02	0,091	
A2010650	FP3/3	9" 3/4	1" F	122 x 311	12	13,22	0,091	
A2010720	FP3/3	20"	1" F	122 x 570	6	10,06	0,108	



D: 44
E: 33
F: ø4

Designed to hold cartridges:

5" 7" 9" 3/4 20"



FP3/3 FILTER CARTRIDGE HOUSING WITH OPAQUE WHITE SUMP

CODE	MOD	HEIGHT	INLET/OUTLET	DIMENSIONS	QUANTITY	kgs	VOLUME	
								c
A2040350	FP3/3	5"	1/2" F	122 x 189	24	20,74	0,112	
A2040360	FP3/3	7"	1/2" F	122 x 240	12	12,24	0,091	
A2040370	FP3/3	9" 3/4	1/2" F	122 x 311	12	13,08	0,091	
A2040480	FP3/3	20"	1/2" F	122 x 570	6	10,40	0,108	
A2040380	FP3/3	5"	3/4" F	122 x 189	24	21,05	0,112	
A2040390	FP3/3	7"	3/4" F	122 x 240	12	12,38	0,091	
A2040400	FP3/3	9" 3/4	3/4" F	122 x 311	12	13,27	0,091	
A2040490	FP3/3	20"	3/4" F	122 x 570	6	10,47	0,108	
A2040410	FP3/3	5"	1" F	122 x 189	24	20,93	0,112	
A2040420	FP3/3	7"	1" F	122 x 240	12	12,32	0,091	
A2040430	FP3/3	9" 3/4	1" F	122 x 311	12	13,22	0,091	
A2040500	FP3/3	20"	1" F	122 x 570	6	10,45	0,108	

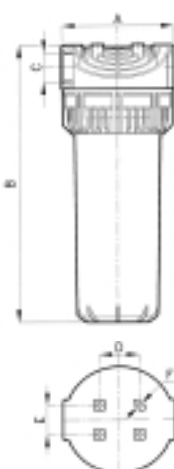

D: 44
E: 33
F: ø4

LINEA SIRIO

The Sirio Line of cartridge containers differs from all the other lines in that Sirio containers have female-thread heads and male-thread sumps. This creates greater strength in what is usually the critical point in a container—the point where the sump and the head join—and creates a higher breakage threshold for the container. Like the Aqualux Line, Sirio container heads have special circular ribbing, which increases stability and resistance to pressure.

Sirio is effective in all applications where exceptionally high performance is required.

The line comes in the two-piece series, with exclusively female-thread couplings, without brass inserts and brass relife valves. The line is designed for wall mounting.

All containers are designed to hold standard

filter cartridges measuring 5, 7, 9 3/4, 20 inches. They allow handling medium capacities, and are particularly suitable for technical, domestic or residential use.

All containers come without cartridges, and have blue heads and transparent (Blue SAN) or white (Opaque PP) sumps.

Other colors are available upon request for bulk orders.

The package is neutral, but may be personalized upon request for bulk orders.

sirio line



FP2/4 sirio

TECHNICAL FEATURES

Head:	PP without brass inserts
Sump:	transparent SAN- PP white
O.RING:	NBR 70 Sh
Working pressure:	8 bar max
Burst pressure:	35 bar max
Working temperature:	0°C + 50°C min/max
Capacity (empty) at 2 bar:	1/4" F 32,66 lt/min - 3/8" F 86,70 lt/min - 1/2" F 106,60 lt/min - 3/4" F 108,50 lt/min - 1" F 105,60 lt/min
Life test:	200.000 cycles from 0-10 bar

FP2/4 FILTER CARTRIDGE HOUSING WITH TRANSPARENT SAN SUMP



CODE	MOD	HEIGHT	INLET/OUTLET	DIMENSIONS	QUANTITY	kgs	VOLUME
					box		package
A1070010	FP2/4	5"	1/4" F	124 x 177	24	17,84	0,112
A1070020	FP2/4	9" 3/4	1/4" F	124 x 301	12	12,53	0,091
A1070030	FP2/4	20"	1/4" F	124 x 559	6	10,32	0,108
A1070040	FP2/4	5"	3/8" F	124 x 177	24	17,84	0,112
A1070050	FP2/4	9" 3/4	3/8" F	124 x 301	12	12,53	0,091
A1070060	FP2/4	20"	3/8" F	124 x 559	6	10,32	0,108
A1070070	FP2/4	5"	1/2" F	124 x 188	24	18,20	0,112
A1070080	FP2/4	9" 3/4	1/2" F	124 x 312	12	12,71	0,091
A1070090	FP2/4	20"	1/2" F	124 x 570	6	10,34	0,108
A1070100	FP2/4	5"	3/4" F	124 x 188	24	18,00	0,112
A1070110	FP2/4	9" 3/4	3/4" F	124 x 312	12	12,51	0,091
A1070120	FP2/4	20"	3/4" F	124 x 570	6	10,53	0,108
A1070130	FP2/4	5"	1" F	124 x 194	24	19,50	0,112
A1070140	FP2/4	9" 3/4	1" F	124 x 318	12	13,23	0,091
A1070150	FP2/4	20"	1" F	124 x 576	6	10,88	0,108

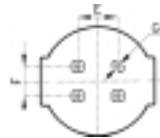

D: ø120
E: 44
F: 33
G: ø4

Designed to hold cartridges:

5" 9" 3/4 20"



Female Threaded Head



FP2/4 FILTER CARTRIDGE HOUSING WITH OPAQUE WHITE SUMP

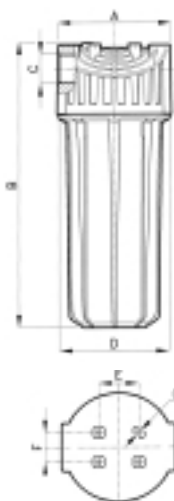

CODE	MOD	HEIGHT	INLET/OUTLET	DIMENSIONS	QUANTITY	kgs	VOLUME
					box		
A1080010	FP2/4	5"	1/4"F	124 x 177	24	18,64	0,112
A1080020	FP2/4	9"3/4	1/4"F	124 x 301	12	13,10	0,091
A1080030	FP2/4	20"	1/4"F	124 x 559	6	10,82	0,108
A1080040	FP2/4	5"	3/8"F	124 x 177	24	18,64	0,112
A1080050	FP2/4	9"3/4	3/8"F	124 x 301	12	13,10	0,091
A1080060	FP2/4	20"	3/8"F	124 x 559	6	10,82	0,108
A1080070	FP2/4	5"	1/2"F	124 x 188	24	19,00	0,112
A1080080	FP2/4	9"3/4	1/2"F	124 x 312	12	13,28	0,091
A1080090	FP2/4	20"	1/2"F	124 x 570	6	10,84	0,108
A1080100	FP2/4	5"	3/4"F	124 x 188	24	18,80	0,112
A1080110	FP2/4	9"3/4	3/4"F	124 x 312	12	13,09	0,091
A1080120	FP2/4	20"	3/4"F	124 x 570	6	11,03	0,108
A1080130	FP2/4	5"	1"F	124 x 194	24	20,30	0,112
A1080140	FP2/4	9"3/4	1"F	124 x 318	12	13,80	0,091
A1080150	FP2/4	20"	1"F	124 x 576	6	11,49	0,108

D: ø120
E: 44
F: 33
G: ø4

Designed to hold cartridges:

5" 9" 3/4 20"

"HIGH PRESSURE" LINE

The High Pressure Line includes the FO3 three-piece containers with brass heads and rings, plastic sumps, and 316/L stainless steel containers. The line is suitable for products used in the semi-professional and the professional sector, where excellent performance is required due to the presence of chemicals and high working pressures and temperatures.

FO 3, the brass head container, comes with a transparent SAN or TROGAMID sump.

All containers are designed to hold standard filter cartridges measuring 5, 7, 9 3/4, 20 inches, with heads designed for wall mounting, and allow handling medium capacities.

FIX, the container made exclusively of stainless steel, comes in the 316/L version.

It is designed to hold filter cartridges measuring 9 3/4 inches or more, and has a head with 1-inch couplings, which can be mounted onto the wall.

The container closes with two side flanges, and has a screw valve on the bottom for emptying liquids from the container.

"high pressure" line



FO3

TECHNICAL FEATURES

Head:	brass
Ring:	brass
Sump:	transparent SAN- Trogamid
O.RING SAN version:	NBR 70 Sh
O.RING Trog version:	VITON
Working pressure SAN version:	8 bar max
Working pressure Trog version:	12 bar max
Burst pressure SAN version:	35 bar max
Burst pressure Trog version:	50 bar max
Working temperature SAN:	0°C + 50°C min/max
Working temperature Trogamid:	0°C + 80°C min/max
Capacity (empty) at 2 bar:	3/4" F 105 lt/min - 1" F 105,99 lt/min - 1 1/4" F 219 lt/min 1 1/2" F 216 lt/min - 2" F 194 lt/min
Life test:	200.000 cycles from 0-10 bar

FO3 HOUSING WITH TRANSPARENT SAN SUMP

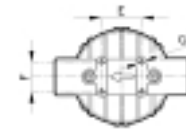
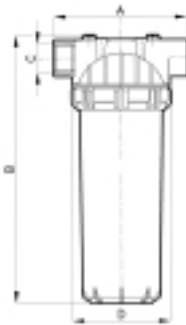

CODE	MOD	HEIGHT	INLET/OUTLET	DIMENSIONS	QUANTITY	kgs	VOLUME
A3010010	FO3	5"	3/4" F	150 x 193	24	46,00	0,112
A3010020	FO3	7"	3/4" F	150 x 244	12	24,76	0,091
A3010030	FO3	9" 3/4	3/4" F	150 x 310	12	25,99	0,091
A3010040	FO3	20"	3/4" F	150 x 573	6	16,62	0,108
A3010050	FO3	5"	1" F	150 x 193	24	44,24	0,112
A3010060	FO3	7"	1" F	150 x 244	12	23,95	0,091
A3010070	FO3	9" 3/4	1" F	150 x 310	12	25,18	0,091
A3010080	FO3	20"	1" F	150 x 573	6	16,05	0,108
A3010090	FO3	7"	1 1/4" F	150 x 244	12	24,48	0,091
A3010100	FO3	9" 3/4	1 1/4" F	150 x 310	12	25,68	0,091
A3010110	FO3	20"	1 1/4" F	150 x 573	6	16,31	0,108
A3010120	FO3	9" 3/4	1 1/2" F	150 x 340	6	19,93	0,108
A3010130	FO3	20"	1 1/2" F	150 x 603	6	22,23	0,108
A3010140	FO3	9" 3/4	2" F	150 x 340	6	17,53	0,108
A3010150	FO3	20"	2" F	150 x 603	6	19,80	0,108

D: ø112
E: 45
F: 34
G: M5

Designed to hold cartridges:

5" 7" 9" 3/4 20"

FO3 HOUSING WITH TROGAMID SUMP

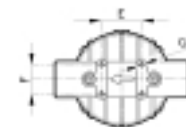
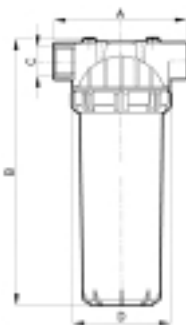

CODE	MOD	HEIGHT	INLET/OUTLET	DIMENSIONS	QUANTITY	kgs	VOLUME
A3020010	FO3	5"	3/4" F	150 x 193	24	46,00	0,112
A3020020	FO3	7"	3/4" F	150 x 244	12	24,76	0,091
A3020030	FO3	9" 3/4	3/4" F	150 x 310	12	25,99	0,091
A3020050	FO3	5"	1" F	150 x 193	24	44,24	0,112
A3020060	FO3	7"	1" F	150 x 244	12	23,95	0,091
A3020070	FO3	9" 3/4	1" F	150 x 310	12	25,18	0,091
A3020090	FO3	7"	1 1/4" F	150 x 244	12	24,48	0,091
A3020100	FO3	9" 3/4	1 1/4" F	150 x 310	12	25,68	0,091
A3020120	FO3	9" 3/4	1 1/2" F	150 x 340	6	19,93	0,108
A3020140	FO3	9" 3/4	2" F	150 x 340	6	17,53	0,108

D: ø112
E: 45
F: 34
G: M5

fix

TECHNICAL FEATURES

Head:	stainless steel 316/L
Sump:	stainless steel 316/L
O.RING:	VITON
Working pressure:	15 bar max
Burst pressure:	60 bar max
Working temperature:	0°C + 100°C min/max
Capacity (empty) at 2 bar:	1" 105 lt/min
Life test:	200.000 cycles from 0-10 bar

FIX HOUSING IN 316/L STAINLESS STEEL

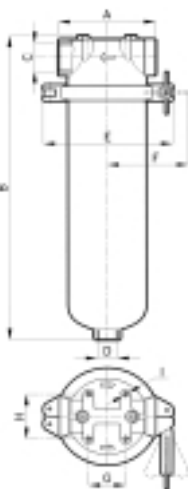

CODE	MOD	HEIGHT	INLET/OUTLET	DIMENSIONS	QUANTITY	kg	VOLUME
			c	a x b e (mm)	box		package
A3030040	FIX	9"3/4	3/4"F	110 x 354 146	6	16,52	0,108
A3030050	FIX	9"3/4	1"F	110 x 354 146	6	16,44	0,108

D: 1/2"
G: 42
H: 52
I: M6

Designed to hold cartridges:

9" 3/4



HOME LINE

The Home Line cartridge containers have been specially designed for domestic use. They are made to be connected directly at the point of use—for example, a kitchen faucet—and are easy to install and to maintain. Home Line containers come in simple, attractive shapes that blend in well with other household appliances. All products in the Home Line come in four-color boxes, which are specially designed for sale to the general public.

WASHING MACHINE SAVER

This is a very economical lime encrustation removing system using polyphosphates. It has been designed for the washing machine or the dishwasher, and is mounted directly on the water in-take pipe. It is compact and made of highly resistant plastic, and is so easy to install that it is not necessary to call a plumber. Washing Machine Saver keeps the washing machine or dishwasher free of lime encrustation, thus reducing consumption of energy and detergent. The polyphosphates contained in the product are effective for about 4 months on the average.

AQUA TOP, AQUA MASTER, AQUA SMART, and AQUA SUB

These are attractive filter cartridge

containers with different types of fittings. They may be mounted directly on sink faucets in the home without the help of a plumber, and they work without electricity. For correct usage, it is necessary to determine correctly which filter cartridge to install, based on the problem to be solved.

AQUA SELECT

This is a small activated carbon filter that is installed directly at the point of use to solve problems with bad odor and taste caused by the chlorine used to treat civic water supplies. The filter is equipped with a small selection device, which allows activating it only when needed, in order to prolong the life of the cartridge. If the product is used correctly for water intended for consumption only, an installed filter cartridge will last about 2 months. A ceramic cartridge, which uses carbon, is also available. In addition to the depurative action of the carbon, the ceramic cartridge also filters out unwanted particles as small as 0.45 of a micron.

home line



salvalavatrice

TECHNICAL FEATURES

Head:	PP
Sump:	transparent SAN
O.RING:	NBR 70 Sh
Working pressure:	8 bar max
Burst pressure:	35 bar max
Working temperature:	0°C + 50°C min/max
Capacity (empty) at 2 bar:	60 lt/min
Suggested Flow Rate:	Max 8/10 it/min
Life test:	200.000 cycles from 0-10 bar

WASHING MACHINE ANTI-SCALE FILTER UNIT

CODE	MOD	DIMENSIONS a x b x c x d	QUANTITY box	kgs	VOLUME package
A8030010	salvalavatrice	60 x 141 x 3/4" F x 3/4" M	28	8,00	0,026

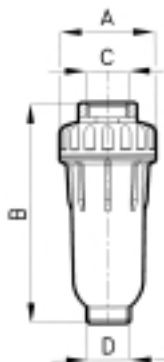

Designed to hold defined cartridges

aqua select

TECHNICAL FEATURES

Body:	ABS
Sump:	transparent SAN
O.RING:	NBR 70 Sh
Working pressure:	5 bar max
Burst pressure:	20 bar max
Working temperature:	0°C + 50°C min/max
Capacity (empty) at 2 bar:	8 lt/min
Flow Rate with cartridge:	carbon: 1,5 it/min anti-bacterial diatomee: 0,8 it/min

AQUA SELECT CARBON

CODE	MOD	HEIGHT	INLET/OUTLET	DIMENSIONS a x b (mm)	QUANTITY box	kgs	VOLUME package
A8090010		2,6"	22 x 1	138 x 105	12	6,00	0,026

AQUA SELECT ANTI-BACTERIAL

CODE	MOD	HEIGHT	INLET/OUTLET	DIMENSIONS a x b (mm)	QUANTITY box	kgs	VOLUME package
A8090020		2,6"	22 x 1	138 x 105	12	6,00	0,026

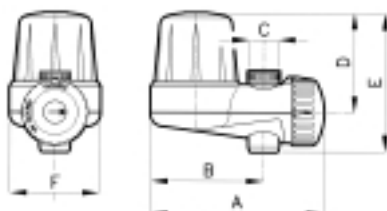

C: M22x1F - M21x1M - M24x1M
D: 80
E: 111
F: ø71

Designed to hold defined cartridges

aqua top-master-smart-sub

TECHNICAL FEATURES

Head:	PP
Sump:	PP - transparent SAN
O.RING:	NBR 70 Sh
Working pressure:	8 bar max
Burst pressure:	35 bar max
Working temperature:	0°C + 50°C min/max
Capacity (empty) at 2 bar:	1/4"F 32,83 lt/min - 1/2"F 106,6 lt/min
Life test:	200.000 cycles from 0-10 bar

AQUA TOP

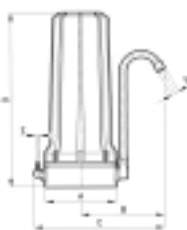

CODE	MOD	HEIGHT	INLET/OUTLET	DIMENSIONS	QUANTITY	kgs	VOLUME
			c	a x b (mm)	box		package
A8050040	V/TRASP	9"3/4	1/4"F	245 x 295	12	16,69	0,091
A8050050	V/OPB	9"3/4	1/4"F	245 x 295	12	17,16	0,091

D: 298
E: ø5.5
F: ø13.5

AQUA MASTER

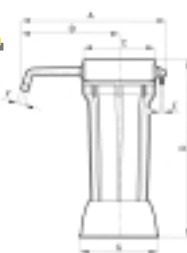

CODE	MOD	HEIGHT	INLET/OUTLET	DIMENSIONS	QUANTITY	kgs	VOLUME
				a x b (mm)	box		package
A8060030	V/TRASP	9"3/4	1/4" x 3/8"	280 x 305	12	15,32	0,091
A8060040	V/OPB	9"3/4	1/4" x 3/8"	280 x 305	12	15,79	0,091

C: ø118
D: 298
E: ø5.5
F: ø15.5
G: 130

AQUA SMART



CODE	MOD	HEIGHT	INLET/OUTLET	DIMENSIONS	QUANTITY	kgs	VOLUME
			c	a x b (mm)	box		package
A8060170	V/TRASP	9"3/4	1/2"F	290 x 305	12	16,29	0,091
A8060180	V/OPB	9"3/4	1/2"F	290 x 305	12	16,76	0,091

C: ø118
D: 298
E: ø5.5
F: ø15.5
G: 130

AQUA SUB

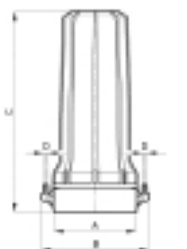

CODE	MOD	HEIGHT	INLET/OUTLET	DIMENSIONS	QUANTITY	kgs	VOLUME
			c	a x b (mm)	box		package
A8050100	V/TRASP	9"3/4	1/4"F	155 x 295	12	16,29	0,091
A8050110	V/OPB	9"3/4	1/4"F	155 x 295	12	17,75	0,091

D: ø5.5

Designed to hold cartridges:

9" 3/4



BIG LINE

Big Line is a line of two-piece containers for medium-sized cartridges. It is suitable for situations where a certain quantity of water is consumed.

The line comes in the AQUA BIG series, measuring 9 and 3/4 to 20 inches, with an opaque (White PP) or transparent (Blue SAN) sump. The heads are made with a female threading without brass inserts and with a plastic blow-off valve, in black PP.

The containers are designed for wall mounting, and all hold filter cartridges with a 4.5-inch diameter measuring from 9 and 3/4 to 20 inches.

All containers come without cartridges, and have black heads and transparent or white sumps. Other colors are available upon request for bulk orders.

The package is neutral, but may be personalized upon request for bulk orders.

big line



aqua big

TECHNICAL FEATURES

Head:	PP without brass insert
Sump:	Transparent SAN - PP white
O.RING:	NBR 70 Sh
Working pressure:	8 bar max
Burst pressure:	35 bar max
Working temperature:	0°C + 50°C min/max
Capacity (empty) at 2 bar:	1" 106,98 lt/min - 1"1/2 194,48 lt/min
Life test:	200.000 cycles from 0-10 bar

AQUA BIG WITH OPAQUE WHITE SUMP

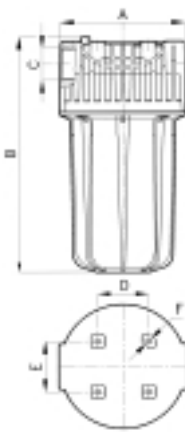

CODE	MOD	HEIGHT	INLET/OUTLET	DIMENSIONS	QUANTITY	kg	VOLUME
			c	a x b (mm)	box		package
A1050010	AB V/OPB	9"3/4	1"	185 x 343	4	10,00	0,062
A1050020	AB V/OPB	9"3/4	1"1/2	185 x 353	4	11,00	0,062
A1050030	AB V/OPB	20"	1"	185 x 615	4	16,00	0,119
A1050040	AB V/OPB	20"	1"1/2	185 x 625	4	16,73	0,119

D: 75
E: 76
F: ø7

Designed to hold cartridges:

9" 3/4 20"



AQUA BIG WITH TRANSPARENT SUMP



CODE	MOD	HEIGHT	INLET/OUTLET	DIMENSIONS	QUANTITY	kg	VOLUME
			c	a x b (mm)	box		package
A1050120	AB V/T	9"3/4	1"	185 x 343	4	10,00	0,062
A1050130	AB V/T	9"3/4	1"1/2	185 x 353	4	11,00	0,062
A1050140	AB V/T	20"	1"	185 x 615	4	16,00	0,119
A1050150	AB V/T	20"	1"1/2	185 x 625	4	16,73	0,119

D: 75
E: 76
F: ø7

Designed to hold cartridges:

9" 3/4 20"



Accessories

KEYS

A6010010	PLASTIC KEY FP2-FP3	
A6011490	PLASTIC KEY FP2 SIRIO	
A6010220	PLASTIC KEY AQUA-KID	
S3010070	METAL KEY FOR FO3	
A6010090	PLASTIC KEY AQUA BIG	

DIFFUSER TUBES

A6010100	DIFFUSER TUBE 5" FOR FP2-FP3 *	
A6010110	DIFFUSER TUBE 7" FOR FP2-FP3 *	
A6010120	DIFFUSER TUBE 9"3/4 FOR FP2-FP3 *	
A6010130	DIFFUSER TUBE 20" FOR FP2-FP3 *	
A6012080	DIFFUSER TUBE 9"3/4 AQUA BIG *	
A6012090	DIFFUSER TUBE 20" AQUA BIG *	

* All these tubes are PP loaded, white color and complete with 80 micron filtering net. This innovative solution, compared to the most common tubes, permits the use even very thin kind of filtering material.

PG010060	O.RING FOR STANDARD HOUSING DIFFUSER TUBE	
MG010480	O.RING FOR AQUA BIG HOUSING DIFFUSER TUBE	
A6010140	DIFFUSER DISC FOR STANDARD HOUSING	
A6011370	DIFFUSER DISC FOR AQUA KID	
A6012100	DIFFUSER DISC FOR AQUA BIG	



BRACKETS AND SUPPORTS

A6010930	SINGLE PLASTIC BRACKET FP2-FP3 HOUSING	
A6011340	DOUBLE PLASTIC BRACKET FP2-FP3 HOUSING	
PN020010	SINGLE METAL BRACKET FP2-FP3 HOUSING	
PN020030	DOUBLE METAL BRACKET FP2-FP3 HOUSING	
PN020070	TRIPLE METAL BRACKET FP2-FP3 HOUSING	
PN020100	SINGLE METAL BRACKET AQUA BIG HOUSING	
PN020040	DOUBLE METAL BRACKET AQUA BIG HOUSING	
A6010070	HOME LINE PLASTIC WALL BRACKET	
A6011390	TABLE BASE TO SUPPORT THE HOME LINE	
A6010080	HOME LINE TOP COVER WITH CALENDER	

ADAPTORS

A6010150	FAUCET AQUABLOCK D.6	
AA010010	UNIVERSAL COUPLING M22X1 TAP	
A6010180	CHROMATE BRASS/PLASTIC BY PASS M22X1	
AB050020	DOUBLE METAL BY PASS	
A6010500	ADAPTER KIT FOR BY PASS M22X1	

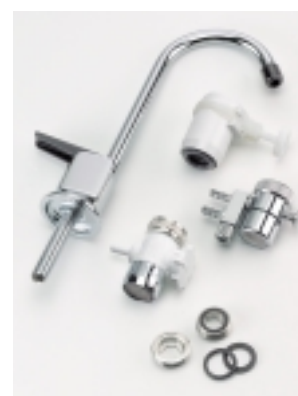

O.RING

MG010020	OR FOR BRASS BREATHER PIPE 8,73 x 1,78 RIF. 108	
MG010010	OR FOR STANDARD SUMP 88,5 x 3,53 RIF. 4350	
MG010200	OR FOR AQUA KID SUMP 68,26 x 3,53 RIF. 171	
MG010400	OR FOR AQUA BIG SUMP 140 x 4	
MG010070	OR FOR WASHING MACHINE PROTECTOR 37,77 x 2,62 RIF. 3150	
MG010070	OR FOR AQUA NET SUMP 37,77 x 2,62 RIF. 3150	
MG010340	OR FOR STAINLESS STEEL SUMP 91,44 x 5,34 VITON RIF. 6362/18	
MG010450	OR FOR AQUA MICRO E MINI SUMP 32 x 3	

Regulations for use and installation

- The cartridge containers must be used exclusively for the purposes prescribed by the manufacturer, following the manufacturer's instructions. The manufacturer does not assume any liability for utilization of the product not authorized by our technical personnel.
- The cartridge containers listed in the catalog are suitable for filtering and treating drinking water or other consumable liquids.
- All cartridge containers must be used with the prescribed water pressure as indicated in the catalog. If higher water pressure is foreseen, or if there are sudden or frequent bursts of pressure, we advise protecting the device by installing a pressure reducer on the pipe that connects to the faucet.
- Use the cartridge containers with liquids at room temperature (20-25°C) or within the temperature limits prescribed in the catalog. If the cartridge container is installed on a pipe connected to a water heater, install a sluice valve to avoid boiling water flowing back into the container.
- Do not use cartridge containers with sumps made of SAN Transparent with liquids containing pH aggressive solutions (chemical products, solvents, detergents, etc.); use these containers only with liquids that have a neutral pH.
With pH aggressive liquids, use only containers with sumps made of PP. Always consult the materials table to make sure liquids are compatible before proceeding.
- Do not use the cartridge containers to filter air or compressed gas, even at low pressures.
- The cartridge containers must not be stored or installed in areas exposed to freezing temperatures or very high temperatures. We advise against installing the containers outdoors or in any area exposed to the elements or to the sun's ultra-violet rays. Such conditions will diminish the device's performance, and will eventually cause it to cease functioning.
- If the container is to be installed in an area exposed to the light, we advise using a container with an opaque sump, in order to prevent consequent growth of bacteria in the liquid being treated.
- If the container is to be mounted on the wall, use the special wall brackets. Connect the containers to the pipes using flexible fittings in order to avoid tension in the pipes, which must be fastened to the wall. The pipe-fittings used must have GAS cylindrical threading. Do not connect conical fittings (Fig. 2) or threaded pipes directly to the device.
- Install the containers in an area that is large enough for carrying out maintenance and replacement of the filter. (Fig. 1)
- During installation, it is necessary to create a by-pass system that will allow cutting off the system during normal maintenance operations or in case of break-down, while at the same time keeping the water supply running. We also advise installing a faucet by which to check to quality of the water being treated. (Fig. 4)
- Do not use sealers, hardening liquids, silicon, hemp, etc., to install the containers. Use only Teflon tape. (Fig. 3)

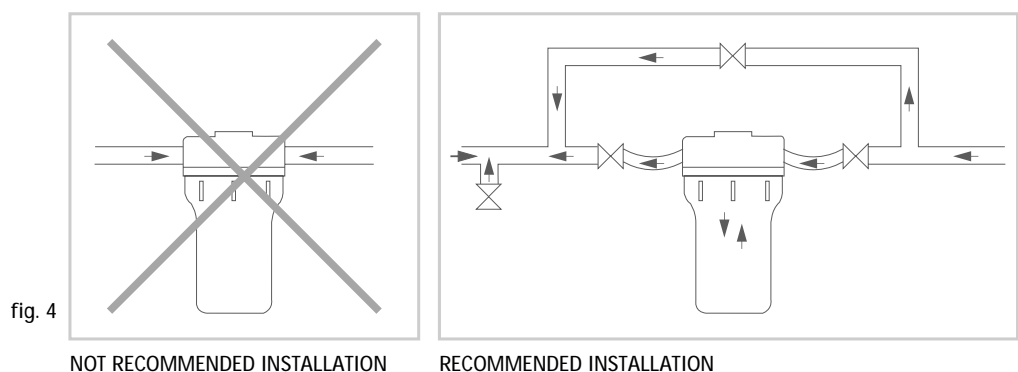
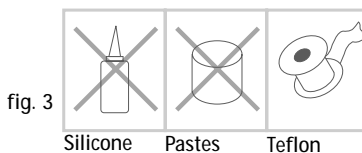
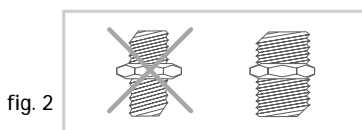
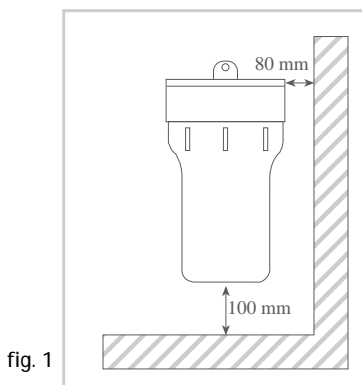



Maintenance

- Make sure the containers are completely tightened while they are being used. If a container is not properly screwed on, water will leak out and flood the area.
- Use only a sponge and running water to clean the containers. **Do not use detergents, solvents, alcohol, or even common household detergents.** Clean the container every time you replace the filter or carry out maintenance on it.
- If the container sump should fall on the floor during cleaning or maintenance, it must be replaced. The fall might cause tiny cracks that are not visible to the naked eye but that could in time cause the container to break, causing flooding in the area.
- Follow the directions in the technical specifications for the filter cartridge for how often to replace or wash the cartridge.

Replacing the Filter Cartridge

- Turn off the water to the container, or turn on the by-pass system if there is one.
- Lessen the water pressure in the device by loosening the blow-off valve on the head of the container. It is important to do this in order to be able to unscrew the container. Use the special wrench to unscrew the container, and proceed with maintenance. Reattach the container, making sure that the o-ring is in place and that the cartridge is correctly positioned. Turn the water back on, holding the blow-off valve open until all the air is out of the container. Close the valve.
- If the container is not used for more than a week, especially during periods when the climate is very hot, run water through it for several minutes before using again, to flush out any bacteria that may have formed.

Warranty

All the articles produced by Aqua are under warranty for a period of one year from the date of purchase. The terms of warranty require that:

- The article be used following the instructions printed by the manufacturer, Aqua.
- Installation and maintenance be carried out following the instructions of the manufacturer, Aqua.
- Goods under warranty be replaced only upon submission of faulty material and upon verification of the nature of the defect, which will be considered in light of technical data available from the data-base in the Aqua engineering department, where the results of daily product testing are recorded.
- Warranty be limited to replacement of the faulty part only, to the exclusion of any other claim by the customer for direct or indirect damages caused by the product.
- The customer pay all labor and transport expenses necessary for replacement of the part covered by the warranty.
- Any warranty on Aqua products be suspended upon failure to comply with the general regulations printed by the manufacturer, or failure to comply with the relevant European regulations in force.

General Sales Terms

- 1) Aqua accepts only written orders and reserves the right to confirm all orders.
- 2) Failure to comply with sales terms, including payment for the goods sold, will automatically result in the suspension of any delivery underway or any previously accepted orders.
- 3) The goods are sold FRANCO AQUA PLANT, meaning that the customer is authorized to collect the goods in the way deemed appropriate.
- 4) In the absence of specific instructions, Aqua will dispatch the goods at their discretion.
- 5) Aqua accepts no liability for the goods after they have left the Aqua warehouses, therefore whoever picks up the goods will have to check to make sure the packages are in good condition and that there is the correct number of pieces, notwithstanding of the type of packing used.
- 6) Aqua reserves the right to make changes in the technical specifications and prices of its products, without providing advance notification.
- 7) Any litigation that may arise will be judged by the Competent Court of Reggio Emilia, the applicable law and the Italian law.

AQUA

USA 0204

fencepool



WATER SYSTEM

AQUA WATER SYSTEM NORTH AMERICA INC
Candlechase drive 18610 - 77388 Spring - Texas
Ph: 001 281 350 2451 - Fax: 001 281 350 2799 - aquawatersystem@ev1.net

The data and descriptions are of a merely illustrative nature and are not binding and may be changed without notice by the manufacturer.